

Data Sheet



Article number: 204080M1080A3SK

Description: E+G levelling foot
GN 40-80-M10-80-A3-SK

Note: SK With nut, External hexagon at the bottom

Measures

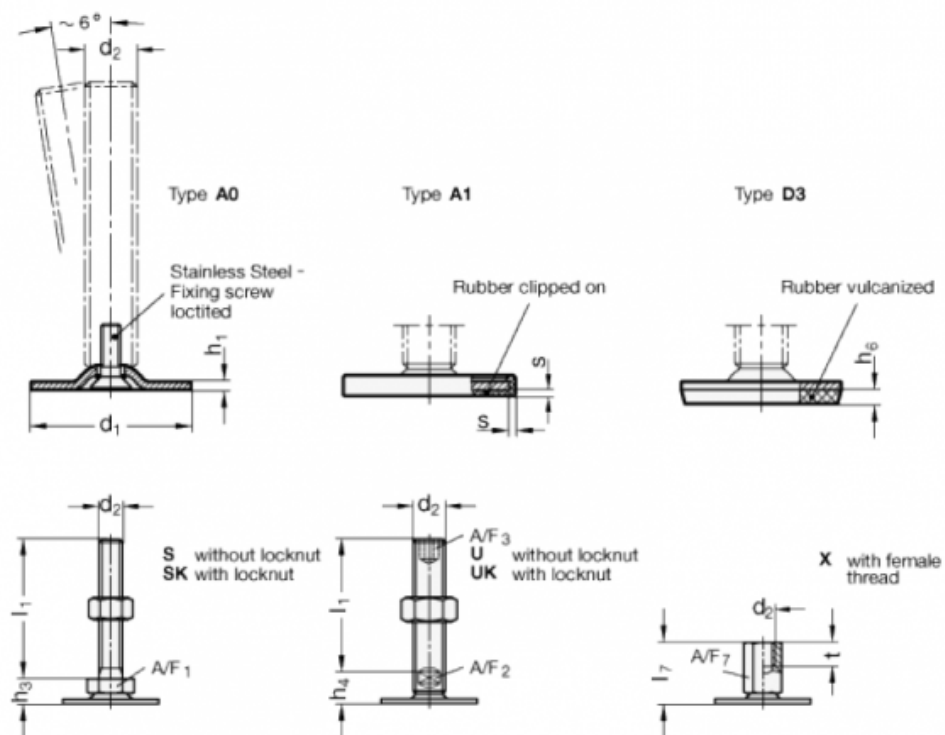

A/F1	= 17
d1	= 80
d2	= M10
h1	= 3
h3	= 12
h6	= 5
l1	= 80
s	=